

**IMPACT**

A BETTER FLOOR



LUXURY VINYL PLANK

---

**PROSPERITY**

2.5 MM

**RESPONSIVE** 

# PROSPERITY

LUXURY VINYL PLANK

RESPONSIVE



**SIZE:** 7.25" x 48"

**THICKNESS:** 2.5 MM

**WEAR LAYER:** 22 MIL | 0.55 MM

**PIECES:** 16 PER CARTON

**COVERAGE:** 38.66 SQ FT / 3.59 M<sup>2</sup> / CARTON

**INSTALLATION:** DRY BACK LVP

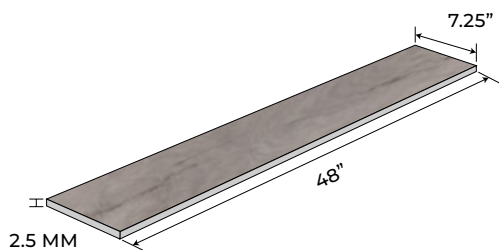

7.25" x 48" x 2.5 mm  
184.15.00 mm x 1219.2 mm x 2.5 mm  
22 MIL / 0.55 mm

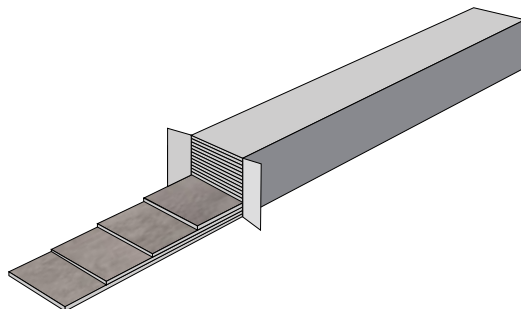

16 PCS / CARTON  
38.66 SQ.FT / CARTON  
3.59 SQ.M / CARTON

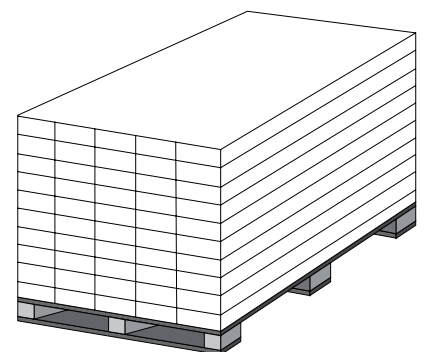

50 CARTONS / PALLET

# PROSPERITY

## LUXURY VINYL PLANK



Loose Lay Luxury Vinyl Planks For Commercial and Light Industry  
 PUR Polyurethane Reinforcement | Product Standard: ISO 10582

CERTIFICATION & CLASSIFICATION	STANDARD	PROSPERITY
TYPE OF FLOOR COVERING	ISO 10582	LUXURY VINYL PLANK
CE CERTIFICATION	EN 14041	YES
CLASSIFICATION	EN ISO 10874	32 / 42

TECHNICAL CHARACTERISTICS	STANDARD	PROSPERITY
TOTAL THICKNESS	EN ISO 2436 (EN 428)	2.5 MM
WEAR LAYER THICKNESS	EN ISO 24340 (EN 429)	0.55 MM   22 MIL
SURFACE TREATMENT	UV TREATED	PUR
MASS PER UNIT AREA	EN ISO 23997 (EN 430)	4.2 KG/M <sup>2</sup>
WEAR LAYER BINDER CONTENT	ISO 10582	TYPE I
FORM OF DELIVERY	EN ISO 24342 ( EN 427) Planks box	7.25" X 48"   16 PLANKS / CARTON = 38.66 SF 184.15 X 1219.2 MM   16 PLANKS / CARTON = 3.59 M <sup>2</sup>

TECHNICAL PERFORMANCE	STANDARD	PROSPERITY
DIMENSIONAL STABILITY	EN ISO 23999 ( EN 434)	≤0.10%
REACTION TO FIRE	EN 13501 – 1	CLASS BFL-S1
RESIDUAL INDENTATION	EN ISO 24343-1 (EN 433)	≤ 0.05M
WEAR RESISTANCE	EN 660-1	GROUP T
CASTOR CHAIR	EN ISO 4918 (EN 425)	NO DAMAGE
CURL RESULTANT TO HEAT	EN ISO 23999 (434)	≤ 2MM
LIGHT FASTNESS	EN ISO 105 – B02	≥ 6
RESISTANCE TO STAIN	EN 438	GRADE 5
RESISTANCE TO CHEMICALS	EN ISO 26987 (EN423)	GOOD RESISTANCE
SLIP RESISTANCE	DIN 51130   EN 13893	R10   CLASS DS
ELECTRICAL PROPERTIES	EN 1815   EN 1081	<2KVON CONCRETE   R1 > 10 <sup>10</sup> Ω
THERMAL RESISTANCE	EN ISO 10456	0.07 M2 K/W



ISO 9001  
 ISO 14001  
 ISO 18001



LIMITED RESIDENTIAL WARRANTY



LIGHT COMMERCIAL WARRANTY



EN 14041

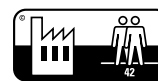

# PROSPERITY

LUXURY VINYL PLANK

RESPONSIVE

## LAYER DIAGRAM

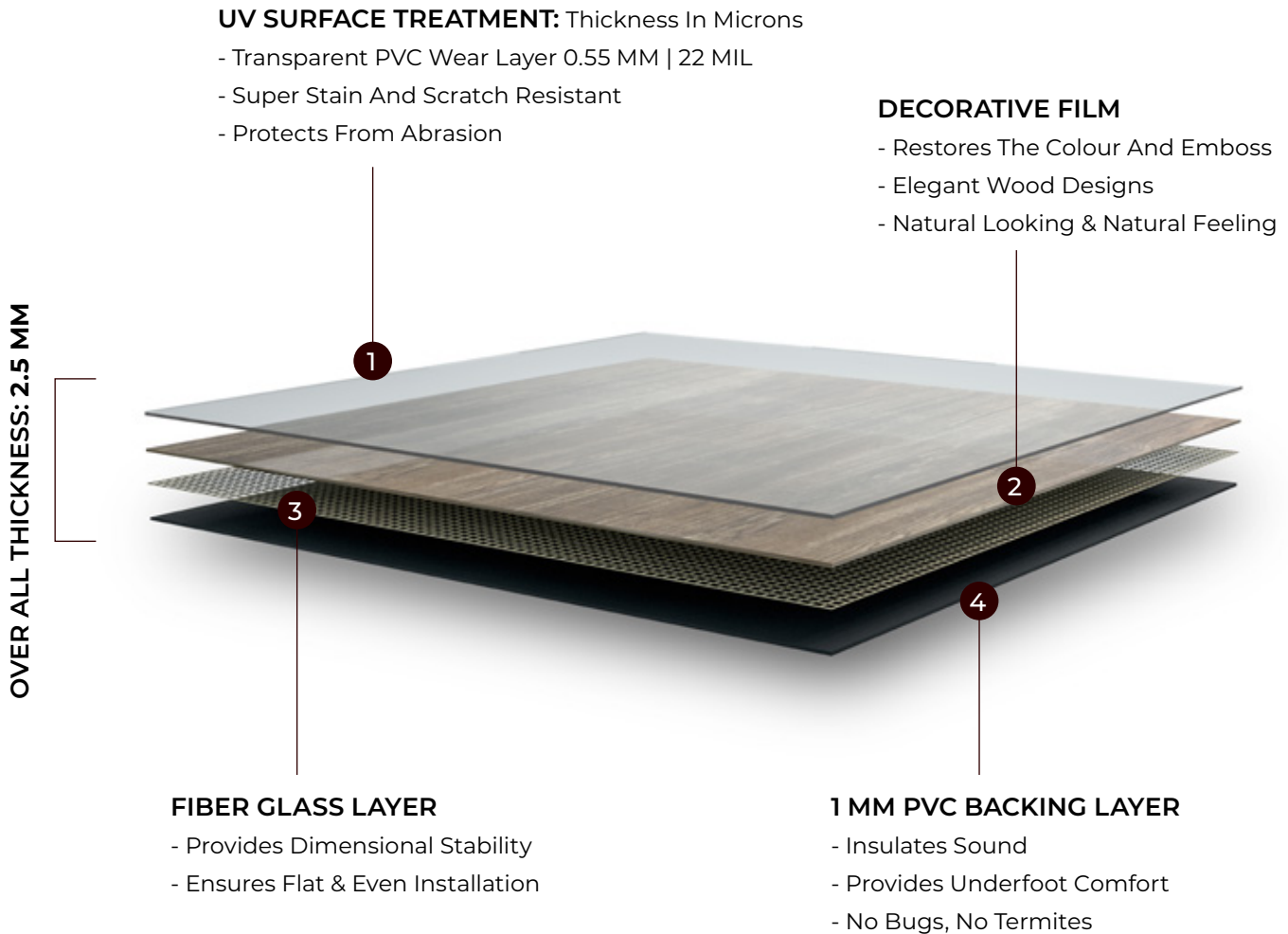

## FEATURES & BENEFITS

Superior Scratch  
& Stain Resistant

Zero  
Maintenance

Easy  
Clean

Natural Looking  
Design

Heavy  
Foot Traffic

Easy  
Installation

## APPLICATIONS

Corporate  
Offices

Commercial  
Establishments

Retail  
Outlets

Hotels &  
Hospitality

---

**FLOURISH**  
IMP-FLHK-13

**RESPONSIVE** 



**FLOURISH**  
IMP-FLHK-13

**RESPONSIVE**



A

B

C

D

E

F

G

H

D

E



---

**THRIVE**

IMP-THCF-14

**RESPONSIVE** 



THRIVE  
IMP-THCF-14

RESPONSIVE



A

B

C

D

E

F

G

H

D

E





---

**SINCERE**

**IMP-SNSC-15**

**RESPONSIVE** 



SINCERE  
IMP-SNSC-15

RESPONSIVE



A

B

C

D

E

F

G

H

D

E

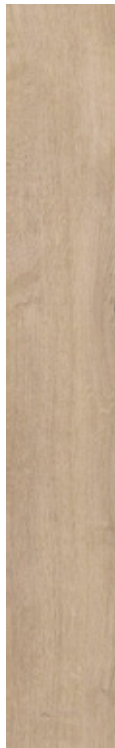
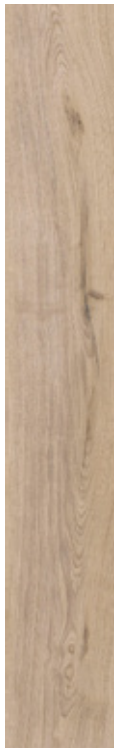
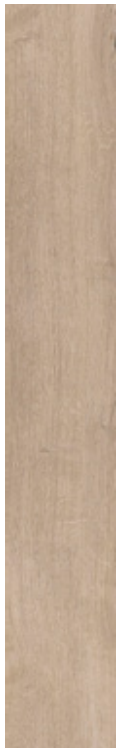
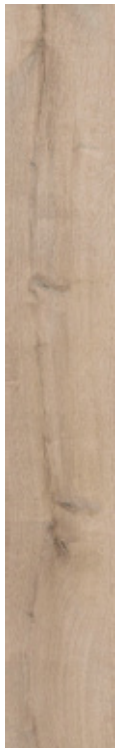
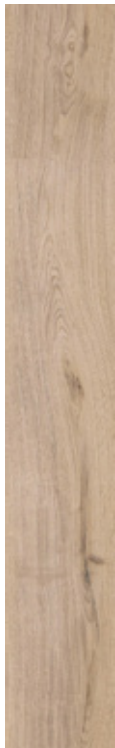

---

**AFFLUENT**  
IMP-AFCT-16

**RESPONSIVE** 



AFFLUENT  
IMP-AFCT-16

RESPONSIVE



A

B

C

D

E

F

G

H

D

E



---

**VIRTUE**

IMP-VRSG-17

**RESPONSIVE** 



VIRTUE  
IMP-VRSG-17

RESPONSIVE



A

B

C

D

E

F

G

H

D

E



---

**FORTUNATE**  
IMP-FTWRH-18

**RESPONSIVE** 



FORTUNATE  
IMP-FTWRH-18

RESPONSIVE



A

B

C

D

E

F

G

H

D

E





---

**AUSPICIOUS**  
IMP-AURB-19

**RESPONSIVE** 



AUSPICIOUS  
IMP-AURB-19



A B C D E F G H D E



---

**TRIUMPHANT**

IMP-TRCO-20

**RESPONSIVE** 



# TRIUMPHANT

## IMP-TRCO-20

RESPONSIVE



A

B

C

D

E

F

G

H

D

E

