

RESPONSIVE



IMPACT
A BETTER FLOOR

PROSPERITY

LUXURY VINYL PLANK | 2.5 MM

LUXURY VINYL PLANK | 2.5 MM



SIZE: 7.25" x 48"

THICKNESS: 2.5 MM

WEAR LAYER: 22 MIL | 0.55 MM

PIECES: 16 PER CARTON

COVERAGE: 38.66 SQ FT / 3.59 M² / CARTON

INSTALLATION: GLUE DOWN LVP

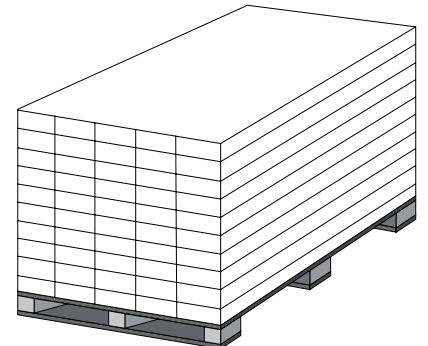
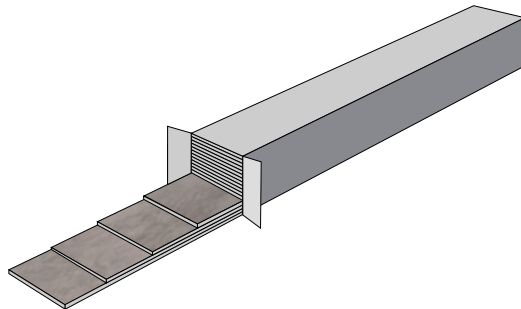
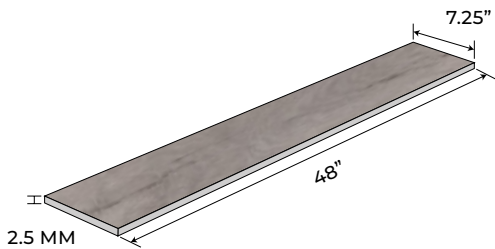

7.25" x 48" x 2.5 mm
184.15.00 mm x 1219.2 mm x 2.5 mm
22 MIL / 0.55 mm

16 PCS / CARTON
38.66 SQ.FT / CARTON
3.59 SQ.M / CARTON

50 CARTONS / PALLET

LUXURY VINYL PLANK | 2.5 MM

LOOSE LAY FOR HEAVY COMMERCIAL USE | **PUR** POLYURETHANE REINFORCEMENT | PRODUCT STANDARD: **ISO 10582**

CERTIFICATION & CLASSIFICATION	STANDARD	PROSPERITY
TYPE OF FLOOR COVERING	ISO 10582	LUXURY VINYL PLANK
CE CERTIFICATION	EN 14041	YES
CLASSIFICATION	EN ISO 10874	HEAVY TRAFFIC: DOMESTIC 23 COMMERCIAL 33

TECHNICAL CHARACTERISTICS	STANDARD	PROSPERITY
TOTAL THICKNESS	EN ISO 2436 (EN 428)	2.5 MM
WEAR LAYER THICKNESS	EN ISO 24340 (EN 429)	0.55 MM 22 MIL
SURFACE TREATMENT	UV TREATED	PUR
MASS PER UNIT AREA	EN ISO 23997 (EN 430)	4.2 KG/M ²
WEAR LAYER BINDER CONTENT	ISO 10582	TYPE I
FORM OF DELIVERY	EN ISO 24342 (EN 427) Planks box	7.25" X 48" 16 PLANKS / CARTON = 38.66 SF 184.15 X 1219.2 MM 16 PLANKS / CARTON = 3.59 M ²

TECHNICAL PERFORMANCE	STANDARD	PROSPERITY
DIMENSIONAL STABILITY	EN ISO 23999 (EN 434)	≤0.10%
REACTION TO FIRE	EN 13501 – 1	CLASS BFL-S1
RESIDUAL INDENTATION	EN ISO 24343-1 (EN 433)	≤ 0.05M
WEAR RESISTANCE	EN 660-1	GROUP T
CASTOR CHAIR	EN ISO 4918 (EN 425)	NO DAMAGE
CURL RESULTANT TO HEAT	EN ISO 23999 (434)	≤ 2MM
LIGHT FASTNESS	EN ISO 105 – B02	≥ 6
RESISTANCE TO STAIN	EN 438	GRADE 5
RESISTANCE TO CHEMICALS	EN ISO 26987 (EN423)	GOOD RESISTANCE
SLIP RESISTANCE	DIN 51130 EN 13893	R 10 CLASS DS
ELECTRICAL PROPERTIES	EN 1815 EN 1081	<2KVON CONCRETE R1 > 10 ¹⁰ Ω
THERMAL RESISTANCE	EN ISO 10456	0.07 M2 K/W



ISO 9001
ISO 14001
ISO 18001



LIMITED RESIDENTIAL WARRANTY



LIGHT COMMERCIAL WARRANTY







EN 14041

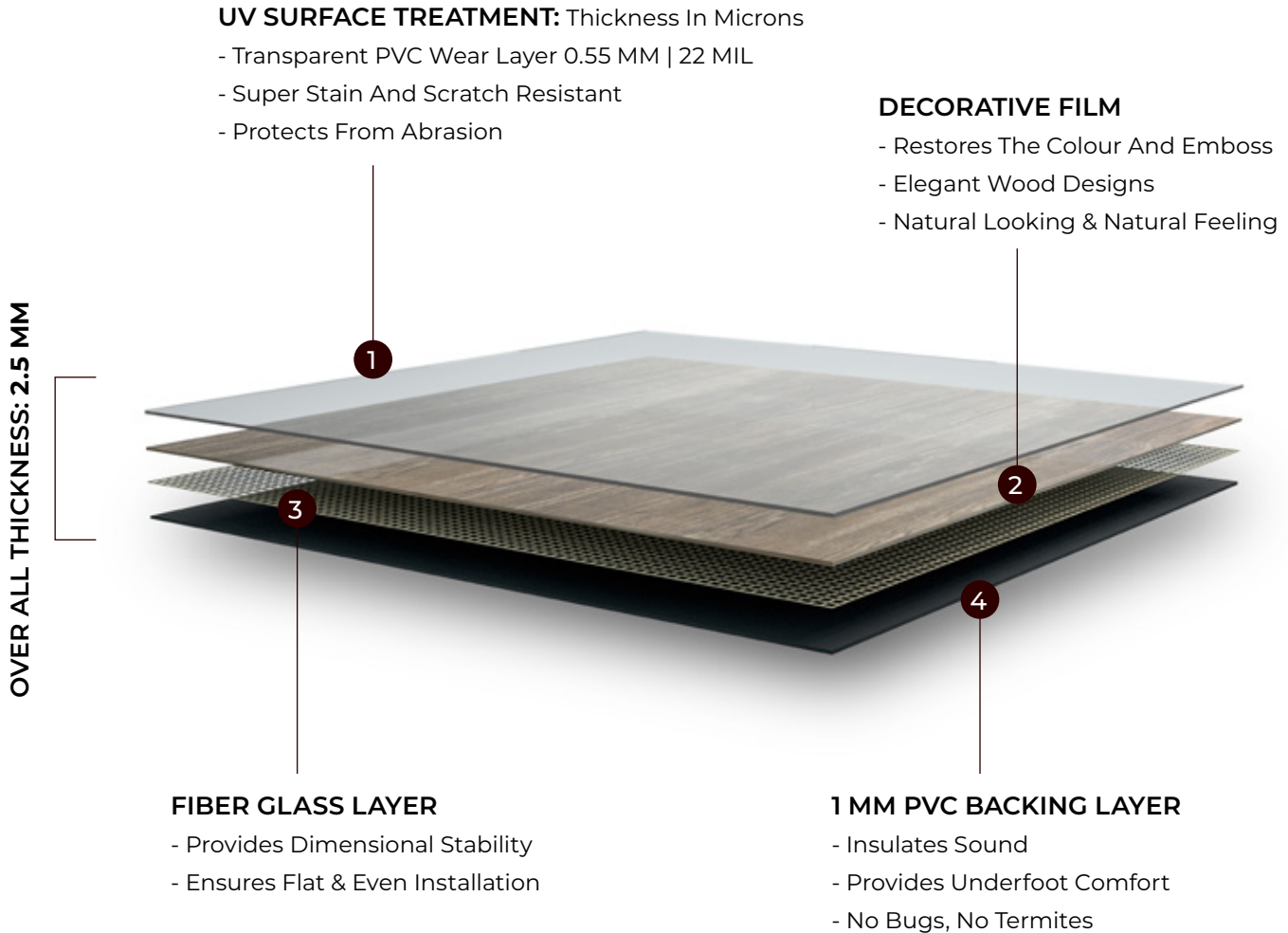





LAYER DIAGRAM

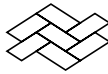

FEATURES & BENEFITS

- | | | |
|---|---|---|
|  |  |  |
| Superior Scratch & Stain Resistant | Zero Maintenance | Easy Clean |
|  |  |  |
| Natural Looking Design | Heavy Foot Traffic | Easy Installation |

APPLICATIONS

- | | |
|---|---|
|  |  |
| Corporate Offices | Commercial Establishments |
|  |  |
| Retail Outlets | Hotels & Hospitality |

FLOURISH
IMP-FLHK-13

RESPONSIVE 



FLOURISH
IMP-FLHK-13

RESPONSIVE



A

B

C

D

E

F

G

H

D

E



THRIVE

IMP-THCF-14

RESPONSIVE 



THRIVE
IMP-THCF-14

RESPONSIVE



A

B

C

D

E

F

G

H

D

E

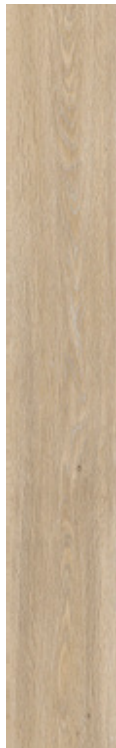

SINCERE

IMP-SNSC-15

RESPONSIVE 



SINCERE
IMP-SNSC-15

RESPONSIVE



A

B

C

D

E

F

G

H

D

E

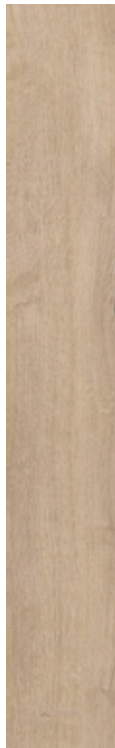
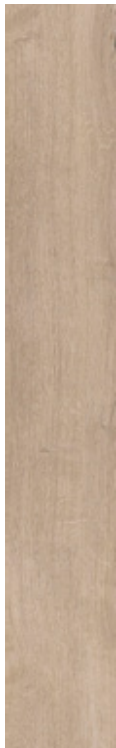
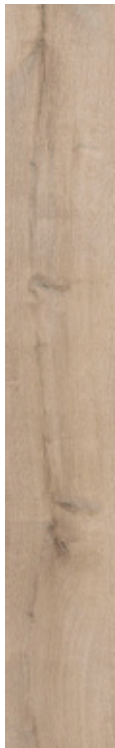
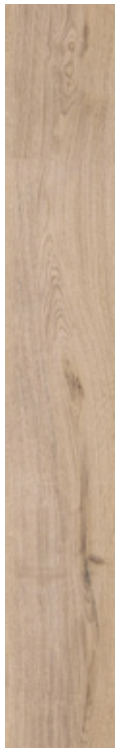

AFFLUENT
IMP-AFCT-16

RESPONSIVE 



AFFLUENT
IMP-AFCT-16

RESPONSIVE



A

B

C

D

E

F

G

H

D

E

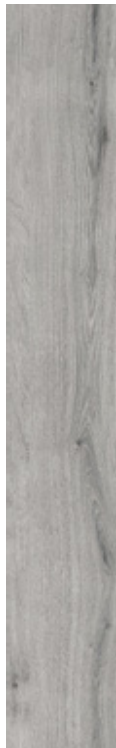

VIRTUE

IMP-VRSG-17

RESPONSIVE 



VIRTUE
IMP-VRSG-17

RESPONSIVE



A

B

C

D

E

F

G

H

D

E



FORTUNATE
IMP-FTWRH-18

RESPONSIVE 



FORTUNATE
IMP-FTWRH-18

RESPONSIVE



A

B

C

D

E

F

G

H

D

E



AUSPICIOUS
IMP-AURB-19

RESPONSIVE 



AUSPICIOUS
IMP-AURB-19



A B C D E F G H D E



TRIUMPHANT

IMP-TRCO-20

RESPONSIVE 



TRIUMPHANT

IMP-TRCO-20

RESPONSIVE



A

B

C

D

E

F

G

H

D

E

